

LCD Video Wall

Narrow Bezel & Ultra Narrow Bezel

TL46H3 | TL46H2

TL46H1

TL40H1



For control room and public venue video wall customers who need a thin profile video wall and uninterrupted operation, our LCD Video Wall System is the ultra-narrow bezel LCD video wall system that provides outstanding tiled visual performance, supports extended operation and requires minimal installation space.

Unlike other products, our LCD video wall combines an ultra-thin profile and easy tiling optimization features in an integrated, mission-critical system design. Our LCD video wall utilizes commercial-grade 40" LCD panels with breakthrough narrow-bezel characteristics resulting in just a 20mm pixel-to-pixel gap between images on adjacent panels in the video wall.

Our LCD Video Wall System makes the most of LCD technology's slim profile and vibrant visual performance while easing the difficulties in achieving perfect alignment, optimal cooling, simplified service and extended operation.

- Tiled image to image gap is only 20mm to provide nearly seamless display.
- Long life time reach to 50000 hours, the "S-PVA" tech to make sure the screen display naturally.
- Fast respond time to be able to playback high speed video.
- Abundant I/O ports make the product with great compatibility and flexibility.
- Long life time & high stability .
- Remote control via RS-232.
- 3D digital Comb Filter and Noise Reduction.
- Power on/off timer.
- Smart working temperature control.
- Up to 178 degrees wide view angle.
- No need for additional controller to align.
- The bezel width is only 20mm.
- Special module design for both single and alignment use.

Specifications of LCD Video Wall

- No controller needed to tile units
- The bezel now as narrow as 20mm
- Full high definition display - 1080p
- Special module design for both single and tiled use
- Long Life Time & High Stability - focusing on professional display



■ Features of LCD Video Wall

No controller needed to tile units

All units in the tiling LCD Wall are controlled by software Eg:3*3tiling

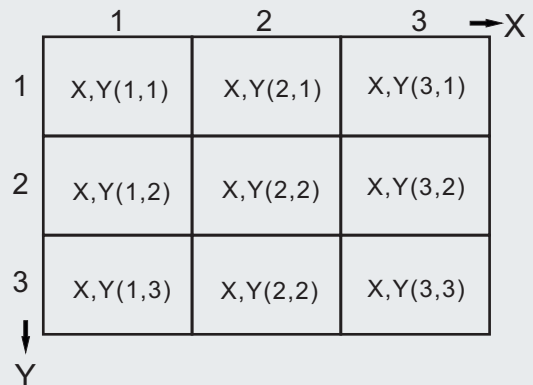

The narrowest bezel

Special technique - only 10mm/set

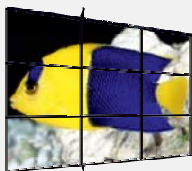

Our LCD wall

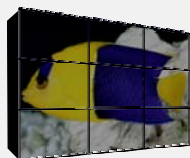

Traditonal LCD Wall

Able to be tiled to work as a video wall and make compensation of image shearing

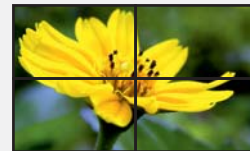

Unique frame correlation function can eliminate the staggering of image caused by the bezel. This function can support tiling LCD walls freely in MxN.

Special tiling technique especially for full screen HD

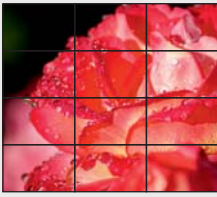

Our LCD wall



Traditional LCD Wall

The resolution of each unit is 1920x1080 and with a special tiling technique the display of the whole screen boasts 1080p HD

40", 46" Tiling LCD Wall adopts unique Samsung DID panels, boasting special display and module structure which are different from conventional LCD.

- Unique SPVA technology
- Special module structure
 - Adoption of heat protection plate & improved ventilation with air gap
 - Adoption of Tni

To find out more about Samsung DID, please visit: http://www.samsung.com/global/business/lcdpanel/flash/pop_did.html

Powerful interface supporting: VGA, RGB/HV, YPbPr, DVI, CVBS.

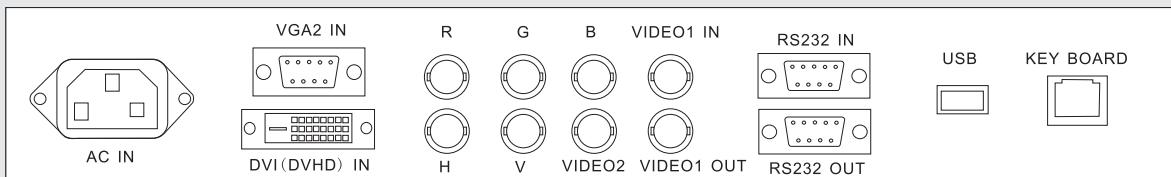

■ Connections of LCD Video Wall

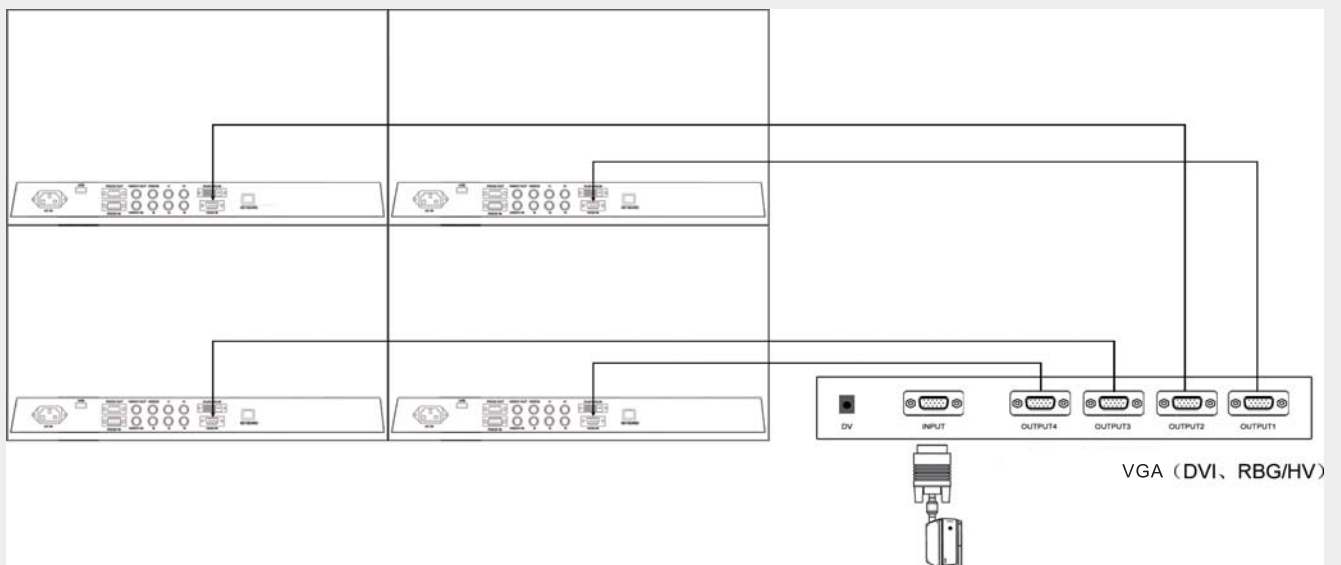

TL40H1

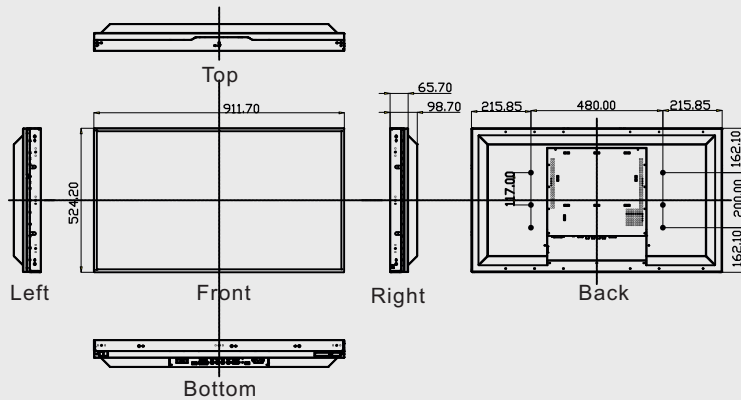

Display Parameters:

Model No	TL40H1	
Screen Size	40inches	
Product Dimension (mm)	911.7(H)x524.2(V)x98.7(D)	
Display Area (mm)	885.168(H)x497.664(V)	
Pixel pitch	0.648 (H) x0.648 (V)	
Resolution	1920x1080	
Brightness	700cd/m ²	
Contrast Ratio	3000:1	
View Angle	178°	
Colours	16.7M	
Response time	8ms	
Colour Temperature	10000K	
Life Time	50000 hours	
Power Consumption	250W(Max)	
Input Signal	Video, VGA, DVI, RGB/HV, YPbPr	
Output Signal	Video	
Control Signal	RS232 IN	DB9(female)
	RS232 OUT	DB9(male)

Application

